

NEON 1700x700mm P-Shape Shower Bath - LH



FEATURES





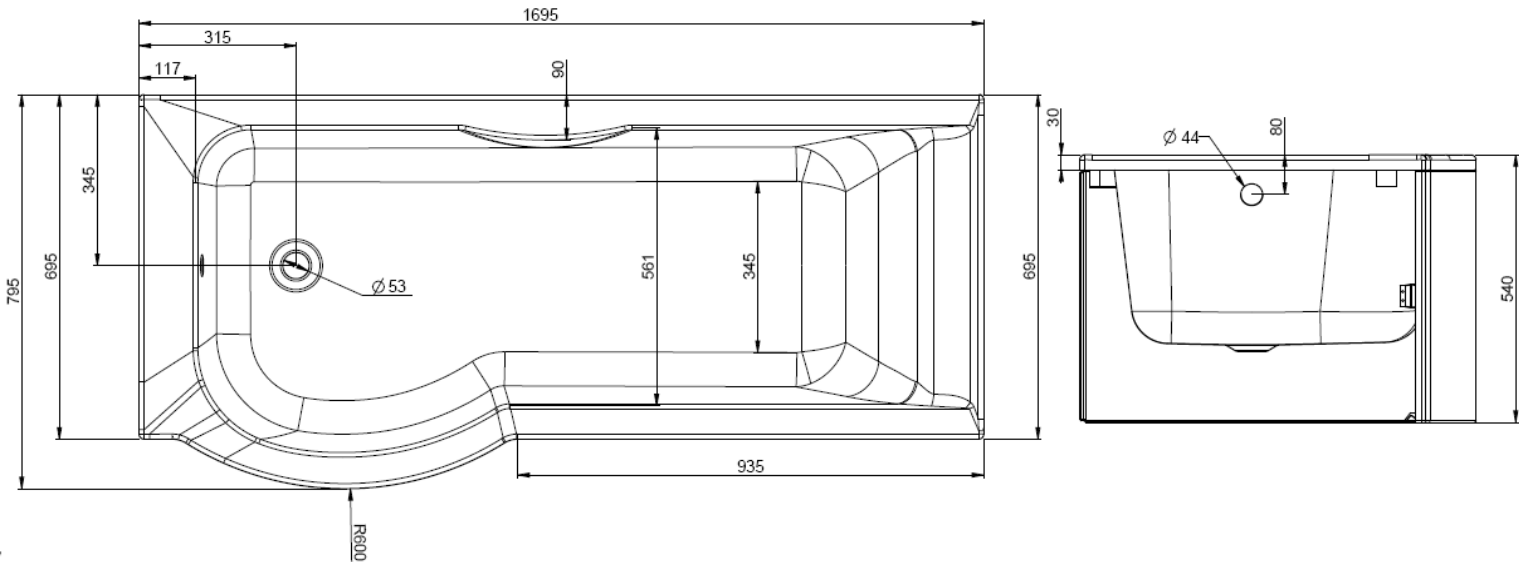

- Size - 1700mm x 700mm
- Tap Holes - 0
- Water Capacity - **187** litres
- Suitable Grips - N/A
- Front Panel - A03033 (S189201)
- End Panel - A03035 (S189301)

SPECIFICATION

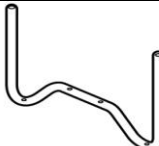
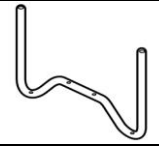
- Part Number - A03025 (S188501)
- Length - 1695 ±5mm
- Width - 695 ±5mm
- Height - 540 mm nominal
- Sheet Thickness - 4mm
- Gross Weight / bath - 22kg
- Pallet Quantity - 8

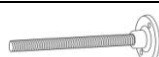
NEON 1700x700mm P-Shape Shower Bath - LH

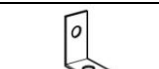
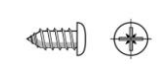
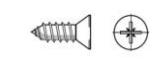
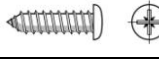
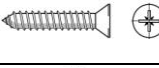
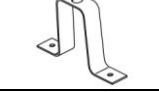
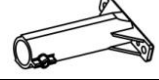
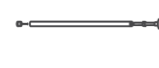

SPARES CODE	INSTRUCTION REFERENCE	DESCRIPTION		QTY
EEEEV06267	B1	Wide Bath Leg		1
EEEEV20067	B2	Narrow Bath Leg		1
PACK EESV02567	D	Short Bath Foot		1
PACK EESV02567	E	Bath Feet		4
PACK EESV02567	G	Bath Feet Locking Nuts		10
PACK EEEV01367	M	Wall Bracket		2
PACK EEEV01367	H	No. 8 x 12 Pan Head Self Tapping Screw		4
PACK EEEV01367	J	No. 8 x 16 Countersunk Woodscrew		2
PACK EEEV01367	K	No. 8 x 20 Pan Head Self Tapping Screw		10
PACK EEEV01367	L	No. 8 x 30 Countersunk Woodscrew		4
PACK EEEV01367	C	Centre Support Leg		1
PACK EEEV01367	F	Plastic Leg Adjuster		4
EEEEV18167	N	Curved Bath Support Leg Pack		1
4583	-	Installation Instructions		1