

## Air Admittance Valves (Ventapipe)

SECTION

6



Air Admittance Valves (Ventapipe)

# Air Admittance Valves (Ventapipe)

## Air Admittance Valves (Ventapipe)

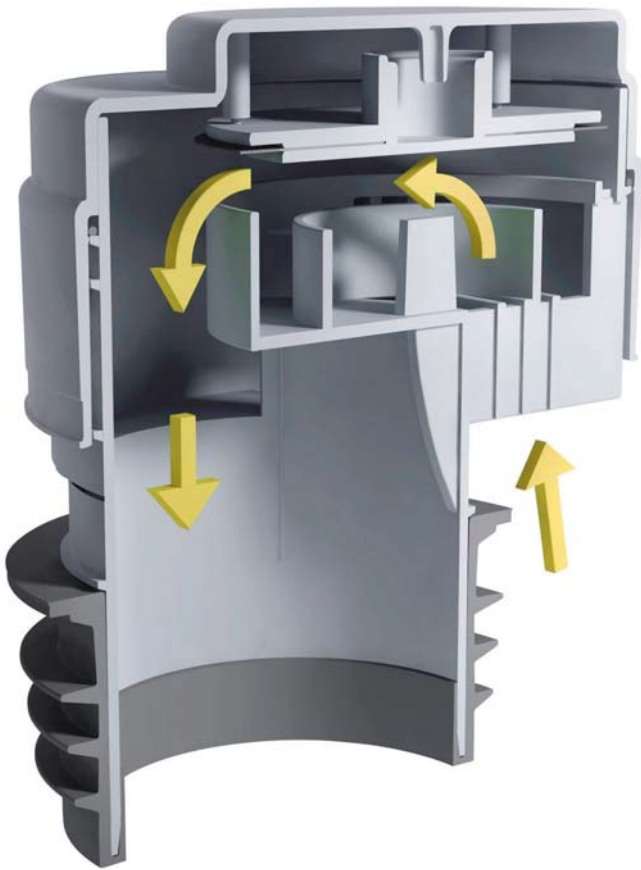

Valve Open

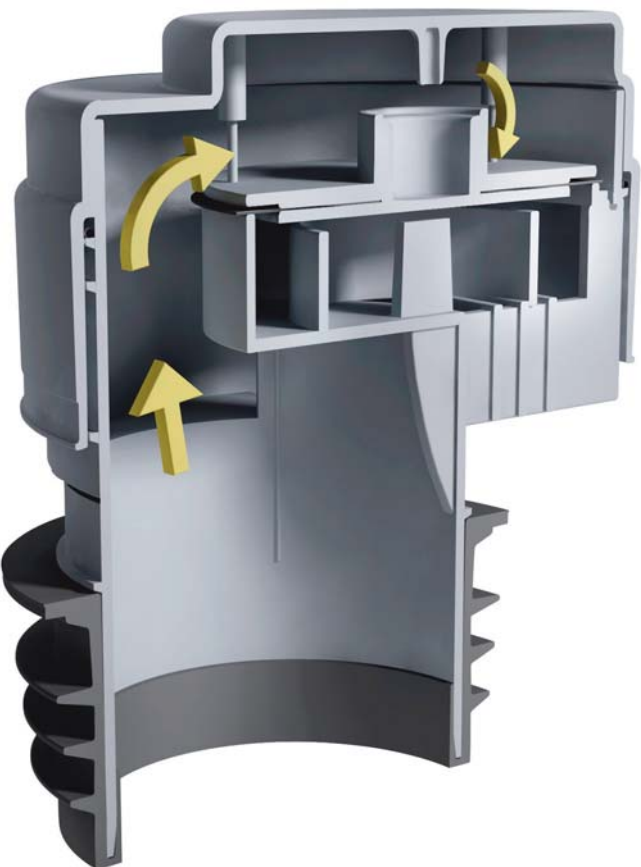

Valve Closed

Code **VP100**

## Ventapipe 100 and Ventapipe 50 Application

Ventapipe 100 and Ventapipe 50 Air Admittance Valves are for use in above ground drainage systems. They are designed to:

- Provide a means of ventilation to the drainage system under conditions of reduced pressure when ventilating pipes are terminated inside buildings in accordance with BS EN 12056-2:2000

### Operation

The two diagrams illustrate how Ventapipe functions. The Valve Diaphragm lifts and allows air to be drawn into the system when it is subjected to negative pressure. On cessation of negative pressure the Diaphragm returns to the closed position thereby preventing the escape of foul air into the building

The Valve is designed to open and close spontaneously when required thereby allowing a supply of air to adequately ventilate the system thus ensuring a smooth discharge

### Approval

Approved Document H of The Building Regulations 2000 (2002 edition) requires that Air Admittance Valves comply with BS EN 12380:2002

All M<sup>C</sup>Alpine Ventapipe Air Admittance Valves listed have been independently tested by the LGA Testing House and certified as being compliant with BS EN 12380:2002 and designated as Class A1

This means that Ventapipe can be installed:

- Above or below the flood level of connected appliances
- Ventapipe has an operating temperature range of -20°C to + 60°C
- Ventapipe was granted A1 Classification without the necessity of a polystyrene cover
- Ventapipe have been tested at -250 Pa for their Air Flow Capacity and the Flow Rate is stated alongside each Valve listed

### Quality Certificate

The LGA Quality Certificate certifies a product's high and consistent quality. It confirms the performance capability (functional characteristics, wear and tear and service life) of a product and therefore its comprehensive quality. Annual production inspections ensure its consistent quality. Whenever the LGA Quality Certificate is on a product it ensures it has been thoroughly tested



### Advantages

- Ventapipe enables ventilating pipes to be terminated inside the building thereby avoiding roof penetration
- Ventapipe allows greater flexibility in design of new drainage systems
- Ventapipe allows greater flexibility when installing additional appliances to existing drainage systems
- Ventapipe eliminates problems of freezing associated with external pipes
- Ventapipe is suitable for use with either plastic or metal pipes
- Ventapipe offers cost savings in both material and labour

### Information for General Guidance only

- Underground foul drainage should be ventilated by a flow of air. A ventilating pipe should be provided at or near the head of each main drain
- An open ventilating pipe, without an Air Admittance Valve, should be provided on any drain fitted with an intercepting trap, particularly on a sealed system and on any drain subject to surcharge
- Air Admittance Valves should not be used when the soil stack provides the only ventilation to septic tanks or cesspools
- Air Admittance Valves should not be used where there is no open ventilation on a drainage system or through connected drains and therefore alternative arrangements to relieve positive pressures should be considered
- Air Admittance Valves should not be used outside buildings or in dust laden atmospheres. They should be located preferably in a non

habitable space, such as a duct or roof. The space should have adequate ventilation and be accessible for maintenance

- Air Admittance Valves should be removable to give access for clearance of blockages
- Air Admittance Valves can indicate the probability of blockages within the drainage system. This can be indicated by high water levels in WC bowls following flushing and the slow draining of appliances upstream from the blockage
- Sizes and limitations upon the use of Air Admittance Valves are subject to national and local regulations and practice. If further detail is required check with the Local Authority Building Control Office
- Kinetic Ram Guns should not be used to shift blockages on installations where Air Admittance Valves are fitted as undue pressure and blowback may cause malfunction

### Ventapipe 15, 25, 40 and 50 Application













VP15, 25, 40 and 50 Air Admittance Valves can be used as alternatives to Anti-Syphon and Resealing Traps to ventilate the waste pipe system in order to overcome problems such as noisy discharge or loss of trap seal caused by induced or self-syphonage. They are particularly advantageous when installing additional appliances to existing waste pipe(s)



Code VP100

# Air Admittance Valves (Ventapipes)

Air Admittance Valves (Ventapipes)

Code	Class	Air Flow Capacity (Litres per second)	Colour	
 <p><b>Ventapipe 100</b> with dual-fit synthetic rubber finger seal outlet for 3"/75mm or 4"/110mm soil pipe 4"/110mm soil pipe - push over rubber seal 3"/75mm soil pipe - push into rubber seal</p> 	VP100	A1	47.2	Grey
 <p><b>Ventapipe 100</b> with Solvent Weld Outlet for 4"/110mm soil pipe</p> 	VP100N	A1	19.4	Grey
 <p><b>Ventapipe 50</b> with dual-fit synthetic rubber finger seal outlet for 3"/75mm or 4"/110mm soil pipe. Also incorporates 2" Universal Outlet 4"/110mm soil pipe - push over rubber seal 3"/75mm soil pipe - push into rubber seal</p> 	VP50-100	A1	16.3	Grey
 <p><b>Ventapipe 50</b> with dual-fit synthetic rubber finger seal outlet for 3"/75mm or 4"/110mm soil pipe 4"/110mm soil pipe - push over rubber seal 3"/75mm soil pipe - push into rubber seal</p> 	VP50P	A1	15.5	Grey
 <p><b>Ventapipe 50</b> with 2" Universal Outlet</p> 	VP50	A1	14.2	Grey
 <p><b>Ventapipe 40/50</b> Solvent Weld Outlet for 1½" or 2" BS EN 1329-1:2000 solvent weld waste pipe</p> 	VPSF-40/50	A1	3.0	White

Code	Class	Air Flow Capacity (Litres per second)	Colour
------	-------	--	--------



**Ventapipe 25** with 1½" BSP thread on outlet



<b>VP1</b>	A1	3.0	Grey
<b>VP1W</b>	A1	3.0	White



**Ventapipe 25** with 1½" Universal outlet



<b>VP2</b>	A1	3.0	Grey
<b>VP2W</b>	A1	3.0	White



**Ventapipe 25** with integral 1½" Multifit Tee

<b>VP3</b>	-	4.5	White
------------	---	-----	-------



**Ventapipe 25** with integral 1¼" Multifit Tee

<b>VP4</b>	-	2.0	White
------------	---	-----	-------



**Ventapipe 15** with 1¼" Universal outlet

<b>VP15M</b>	-	0.5	Grey
--------------	---	-----	------

### Illustrations from BS EN 12056-2:2000 Gravity Drainage Systems Inside Buildings to demonstrate installation variations for Air Admittance Valves

#### Primary Ventilated System Configuration

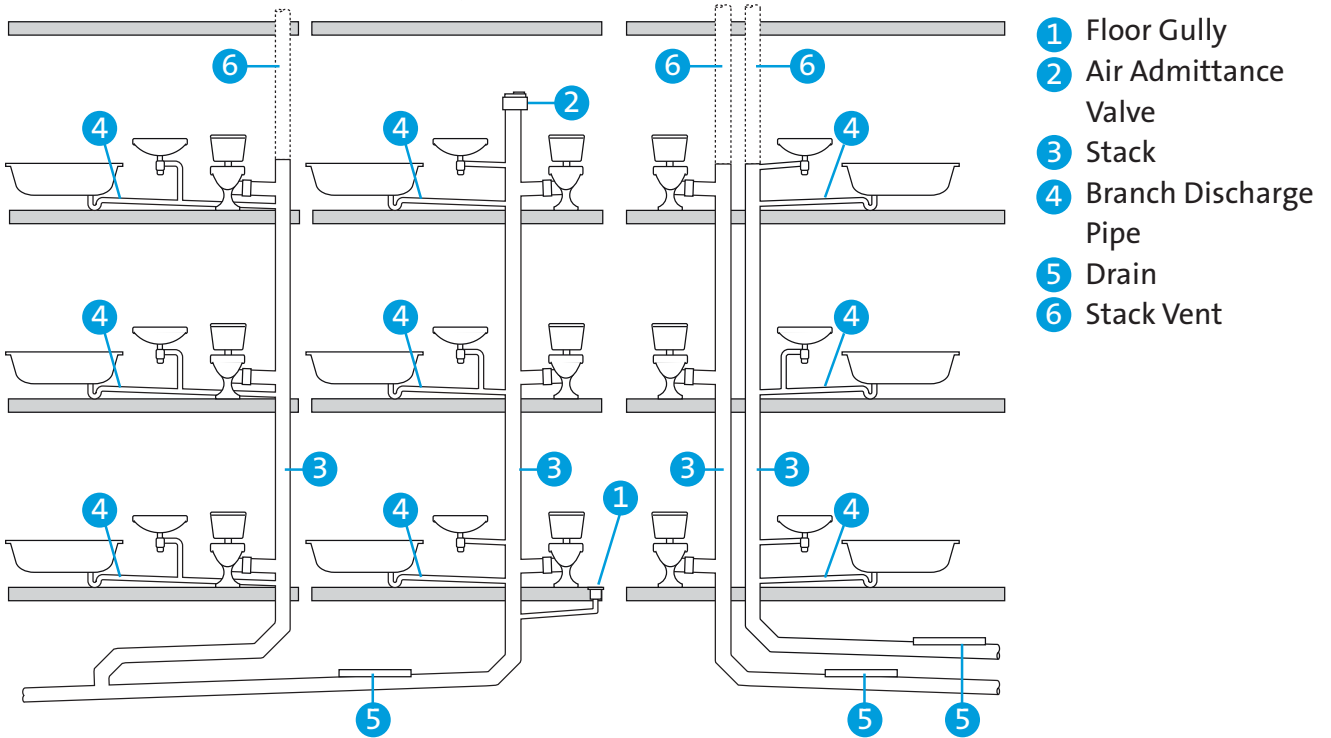

#### Secondary Ventilated System Configuration

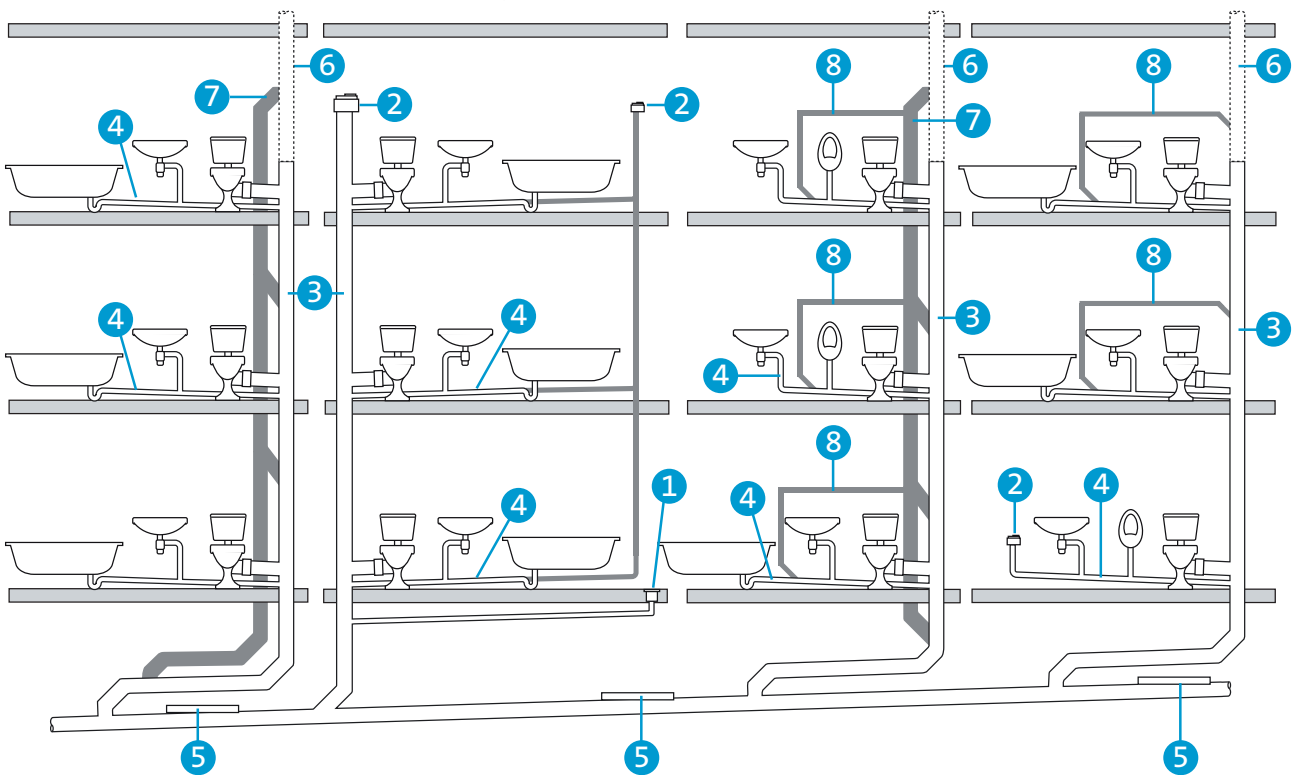

- 1 Floor Gully
- 2 Air Admittance Valve
- 3 Stack
- 4 Branch Discharge Pipe
- 5 Drain
- 6 Stack Vent
- 7 Ventilating Stack
- 8 Branch Ventilating Pipe

Control of pressure in the discharge stack is achieved by use of separate ventilating stacks and/or secondary branch ventilating pipes in connection with stack vents. Alternatively, Air Admittance Valves may be used.